

Installation for Instruction

ITEM NO:LY8104-22

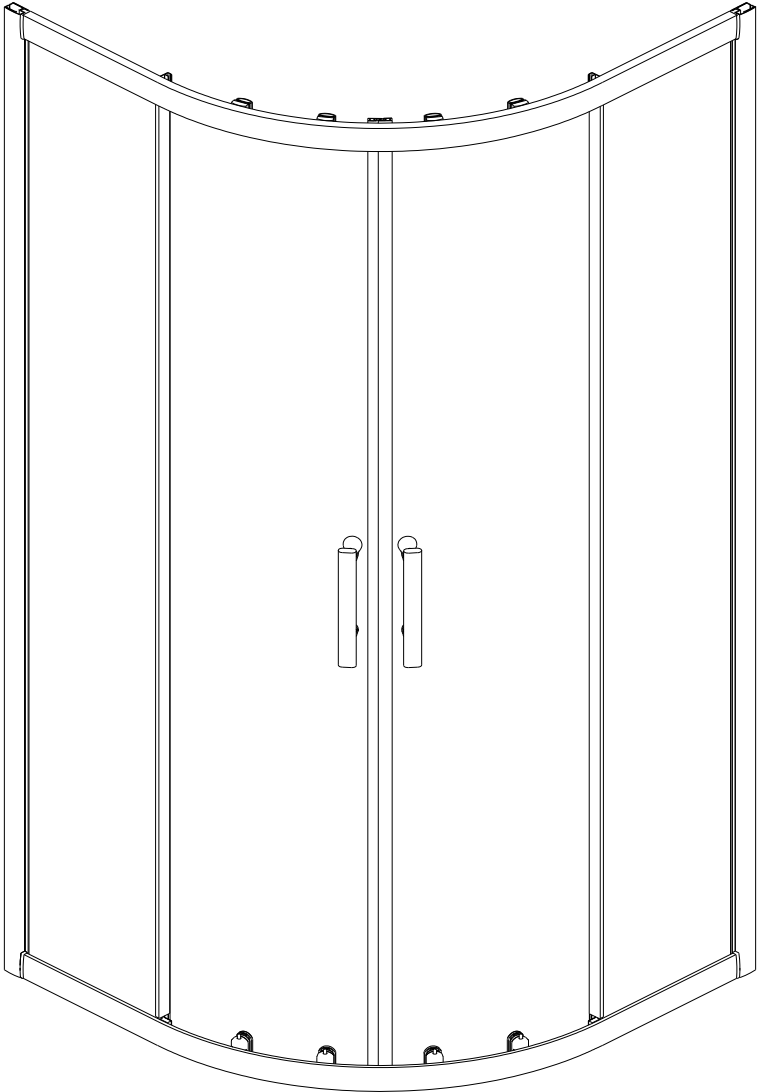



Please read this instructions before installation.

Precautions before installation.

- The shower room should be installed by professionals according to instructions. Otherwise, the shower room may be unstable or fall down which will lead to product broken or people injured.
- Count the object quantity. The glasses must be moved by two people. Put a soft and non-slip object under the glass and stand the glass against a wall smoothly. It will make the glass broken if it is placed in horizontal position. Pay attention to avoid hitting the four corners of the glass.
- Don't strongly knock the glass to avoid being broken.
- Before install the shower room, read the instructions carefully and know well about the tooling and installation sequence.
- It can be used and clean after 24 hour installation.



Maintenance and repair

- 1、 Don't let children, older people or activity restricted people go into the shower room alone.
- 2、 Don't climb,lean against or hang something heavy on the shower room.
- 3、 Don't be rubbed or knocked by hard object, in case to cause broken.
- 4、 Don't make the burning cigarette near the shower room, and don't leave cigarette ash in the shower room. The burning flame will destroy the spray and glass, so it must keep away from fire.
- 5、 Before entering the shower room, pay attention the height of the falling in order to avoid getting tripped.
- 6、 Before entering the shower room, don't put the hand into the crack of the door,in case any injured occur.
- 7、 The soap suds in the shower room will make people slip very easily, Be careful not to slip.
- 8、 The shower room should be kept in good ventilation, in case to avoid leaving the moisture long stay in the shower room, and cause mildew and bad smell.
- 9、 Regularly clean the sliding rail, sliding wheel and sliding lump, add lubricant (lubricant oil or lubricant wax).
- 10、 Regularly adjust the screw of sliding wheel, sliding lump to make sure the effective load bearing and good sliding position of the moving door.
- 11、 Please use neutral liquid detergent and smooth fabric to clean the shower door. Don't use any acidity, alkaline detergent,thinner, alcohol, acetone and any stronge detergent.
- 12、 When dirty water appear on the water retaining stone, you can wipe it with a little toothpaste by wet fabric.
- 13、 It will be leaking if the glass seal is dropped. So please make it up when dropped.

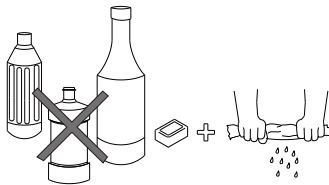

Before you start

Required intallation tools

Not provided

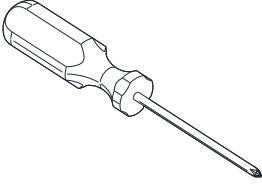

Phillips screwdriver

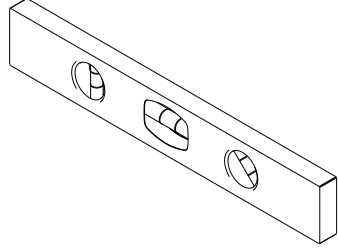

Level

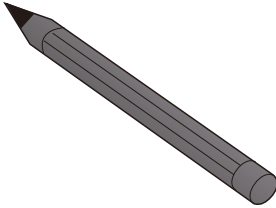

Pencil

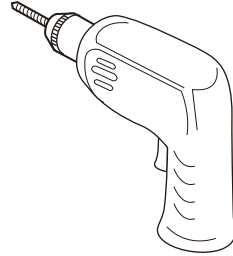

Drill

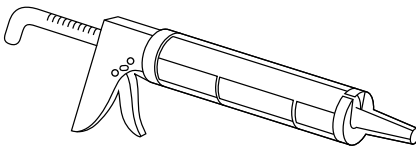

Caulking gun

Parts list

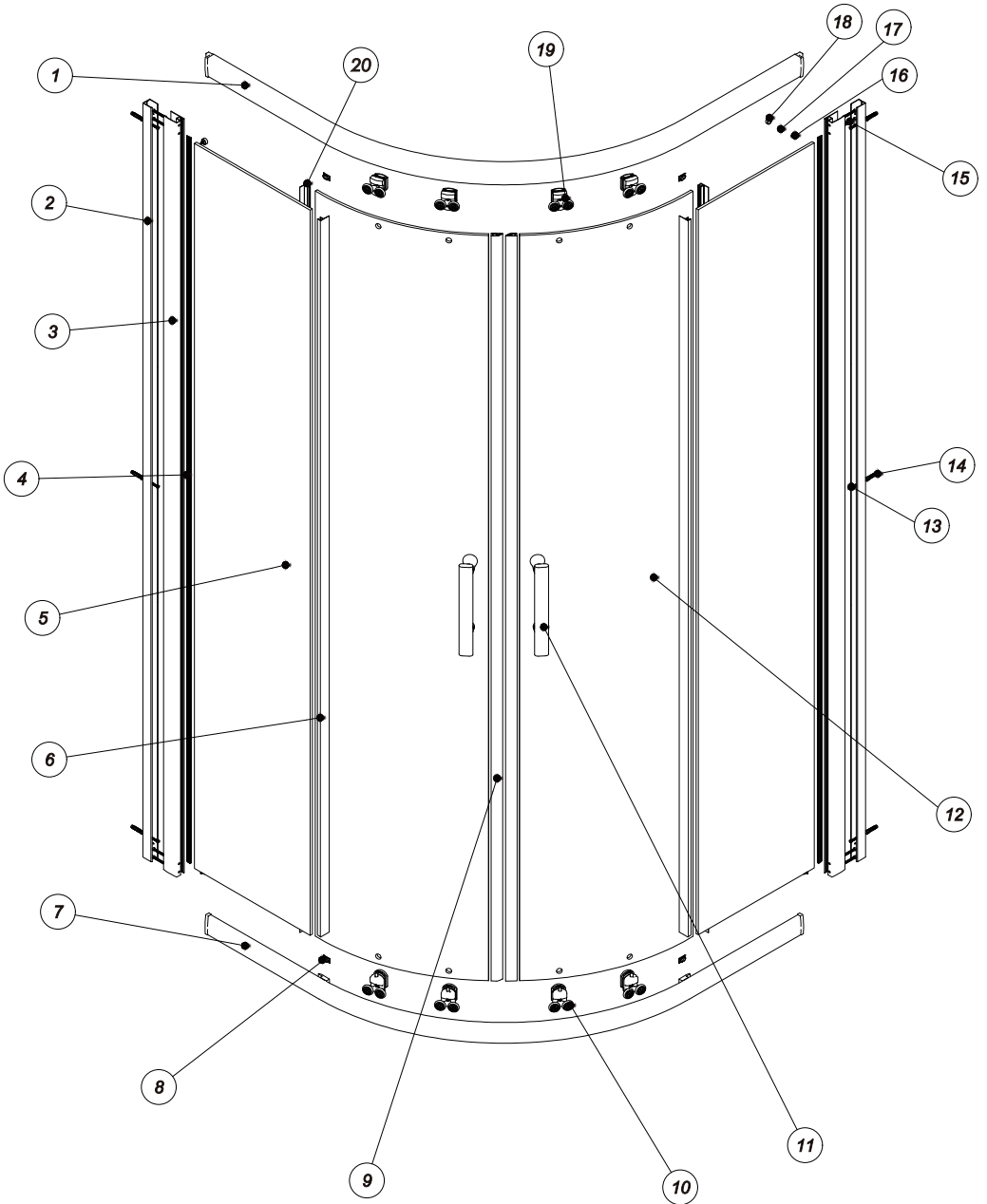

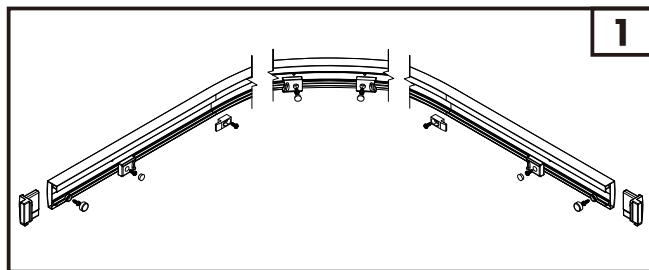

Upper rail set.

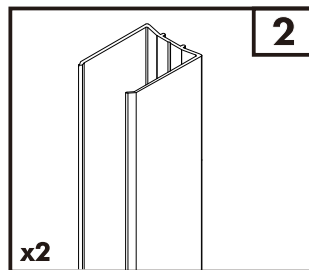

x2

Fixation channel.

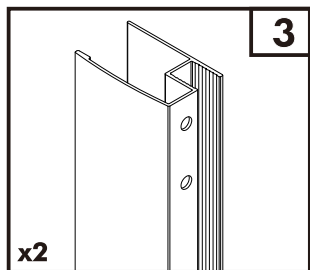

Anodized aluminum profile.

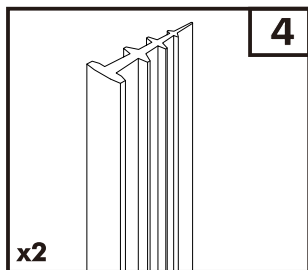

Waterproof silicone seal strip.

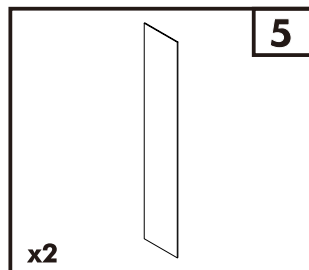

x2

Fixing toughened glass.

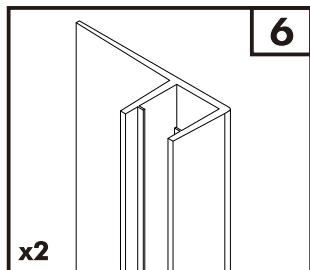

waterproof silicone seal strip

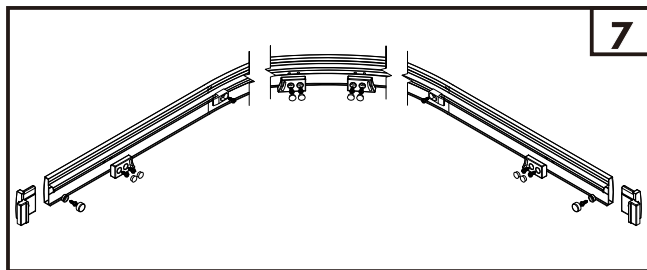

Lower rail set.

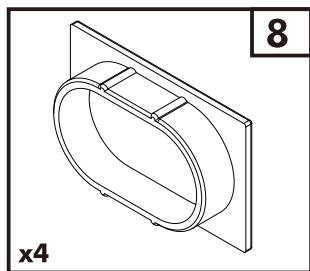

x4

Glass holder cover.

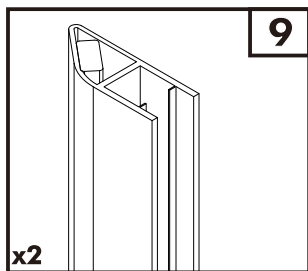

x2

Magnetic silicone bar.

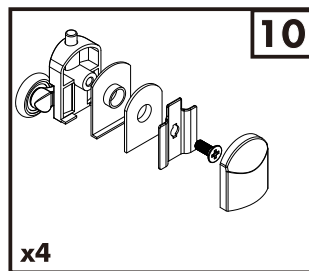

x4

Lower-wheel assembly.

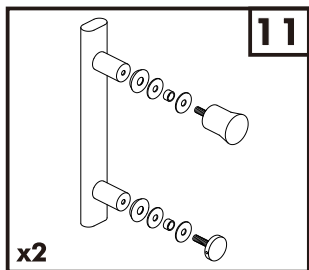

Handle set.

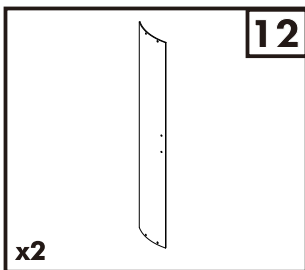

Glass door.

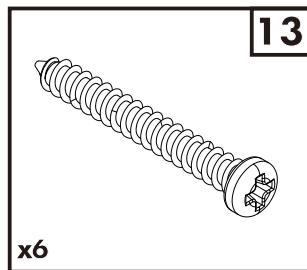

Screw M4x30.

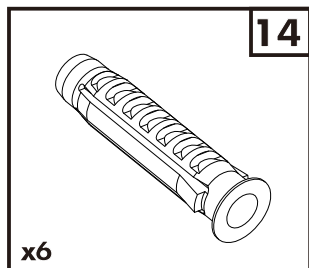

Anchor 6mm.

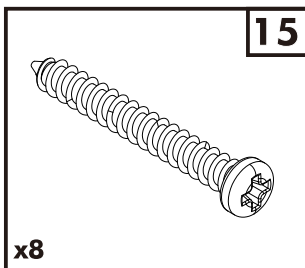

Screw M4X 18.

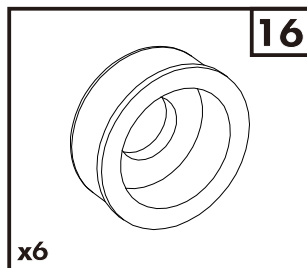

ABS washer.

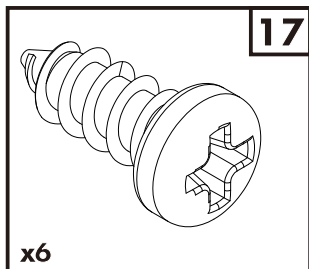

Screw M4x10.

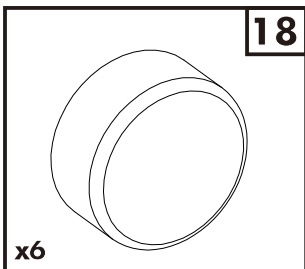

Decorative cover.

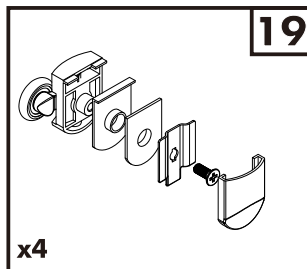

Upper-wheel set.

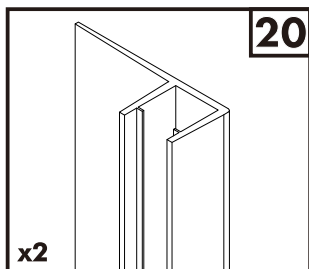

Waterproof silicone seal strip

Door Assembly

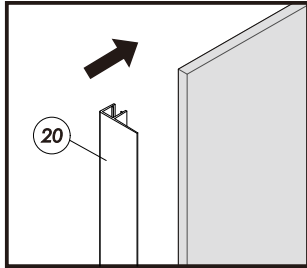

Fix silicone seal strip 20 to the glass.

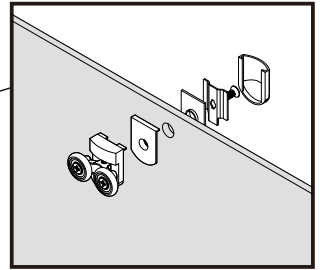

Install the upper wheel set.

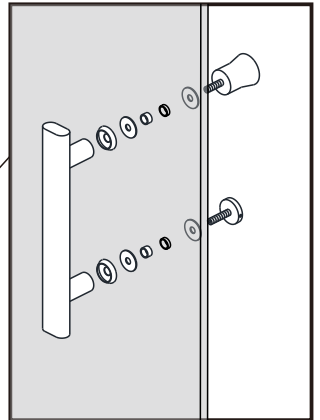

Assemble the handle with the screws at the inside of the cabin.

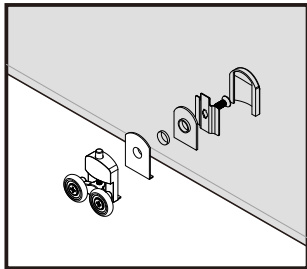

Install the lower wheel set.

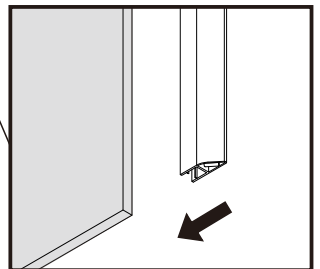

Fix magnetic bar 9 to the handle side.

Assembly

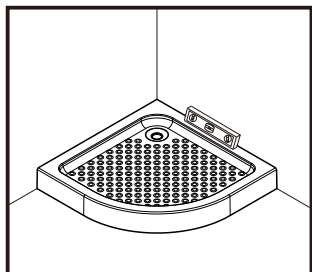

Locate and level the receptacle.

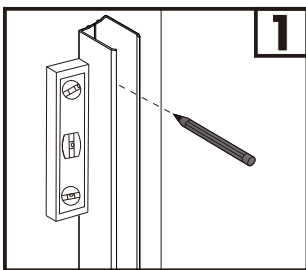

Level the profile 2 and mark the holes for fixing the cabin.

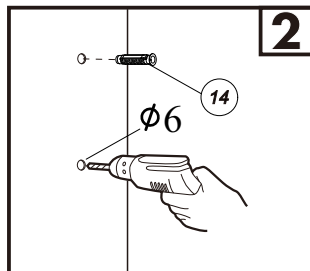

Make the holes and put the anchors.

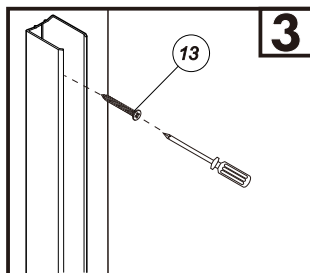
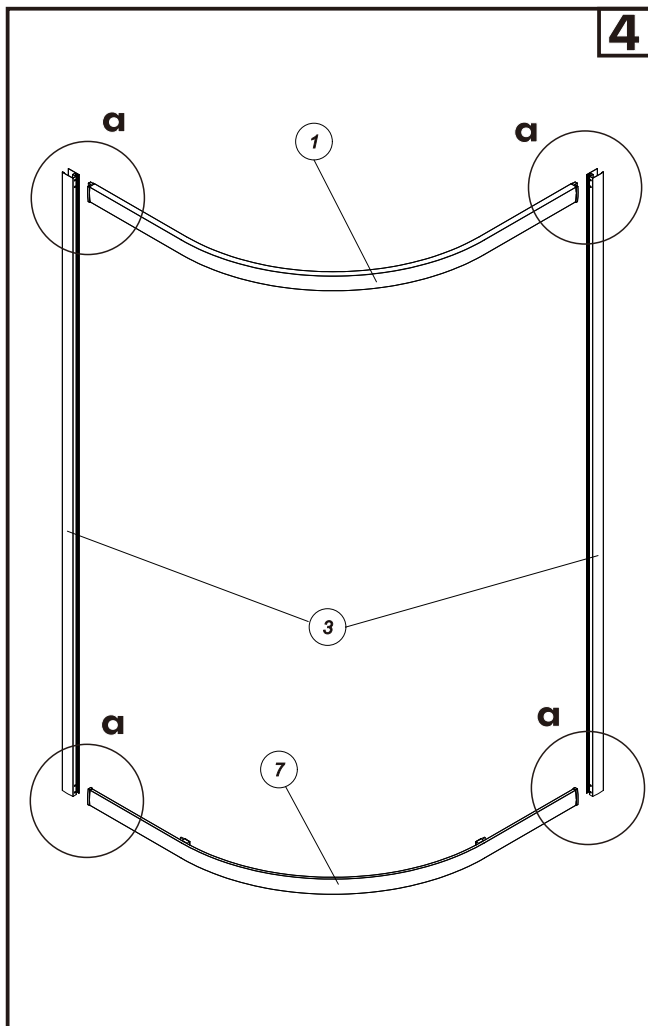

Use screw.

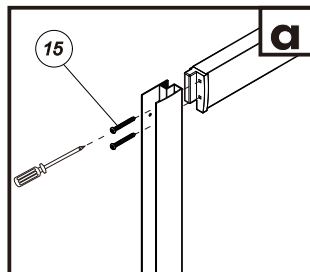

Use screw.

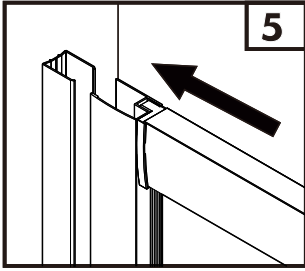

Insert cabin's framework into profile 2 fixed on the wall

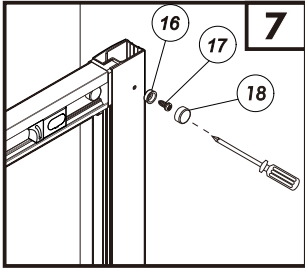

Fix the profiles with the washer 16, screws 17 and decorative cover 18.

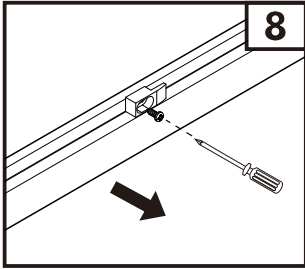

Take off the 4 glass holders.

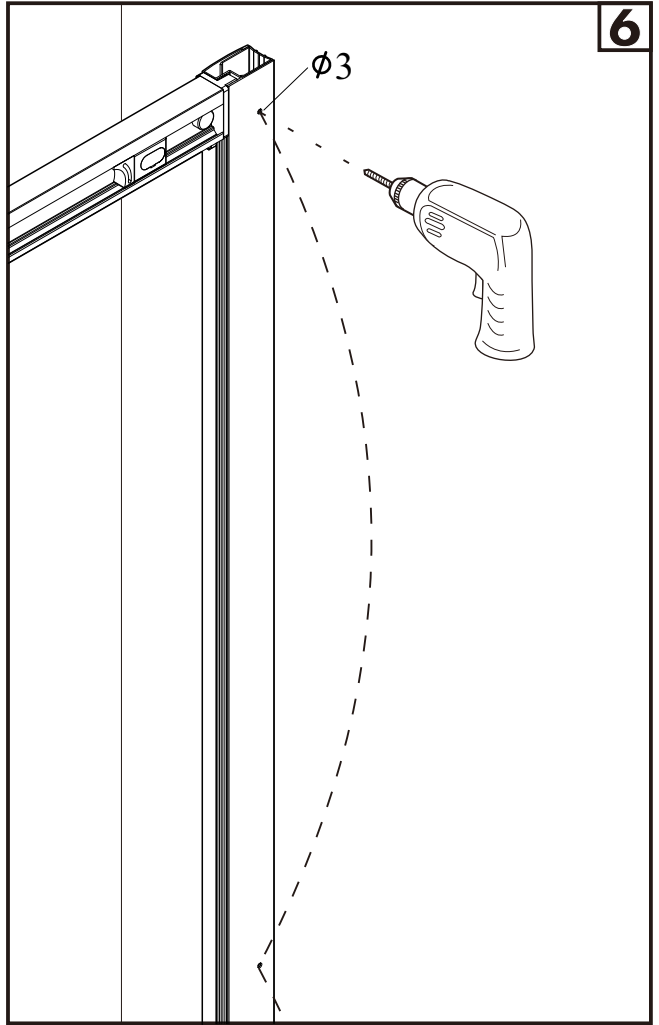

Drill 3 times each profile couple with the electric drill and 3mm drill bit, using the measures as reference.

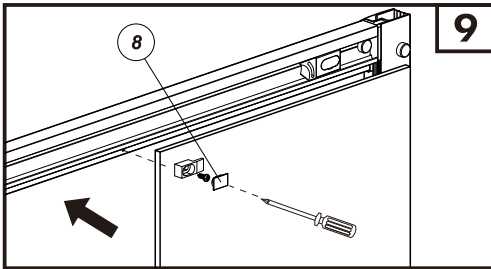

Locate fixing glass on position, fix it with the glass holder and cover 8.

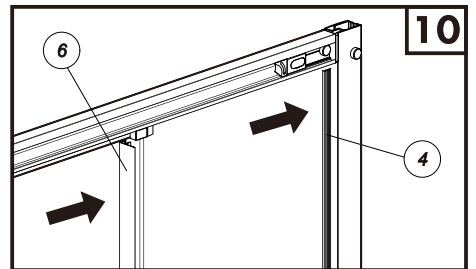

Locate strip seal 4 between fixing glass and profile 3 and the bar 6 on the opposite side.

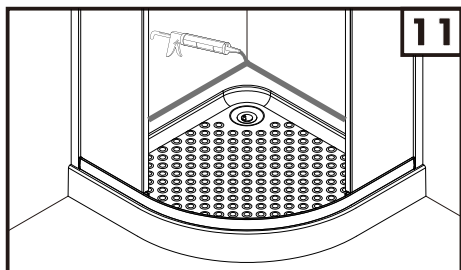

Apply silicone on the receptacle border, filling the gaps within the wall and the receptacle.

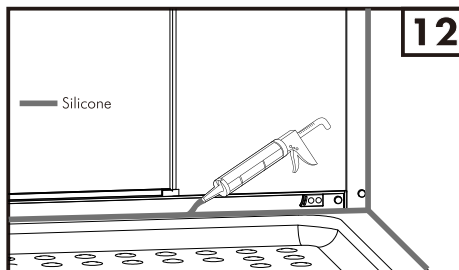

Apply silicone on all borders in contact with the walls and receptacle.

Wait for the silicone dry and continue with the door's installation

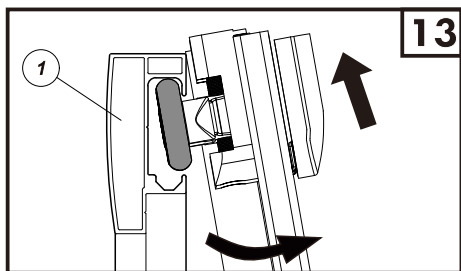

Section view upper rail

Lift and inclinate the glass door as shown in picture of the step 13 and then insert the upper wheels into the upper rail.

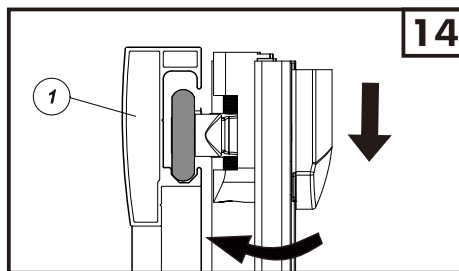

Section view upper rail

Straighten the glass door and get it hangs down slowly. Verify that the all wheel are inside upper rail.

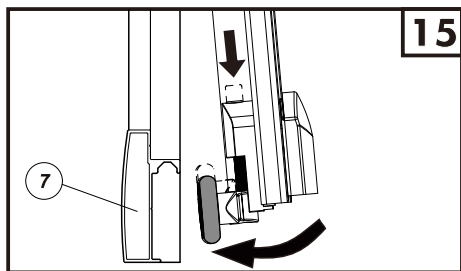

Section view lower rail

Push the button of the lower wheels and locate it into the lower rail.

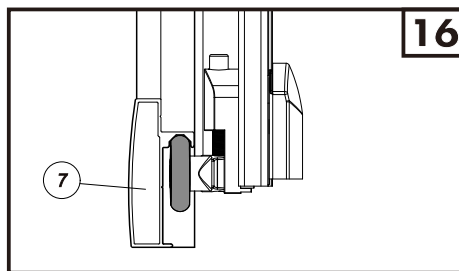

Section view lower rail

Release the button and verify that the 4 wheels are into the rail.